

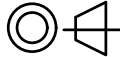

 DYCON <small>power solutions</small>	Description: B Box		Material: Steel
Scale 1:3mm	General Tolerances: +-0.5mm	Projection: 	Date: 09/04/2021 Version:7

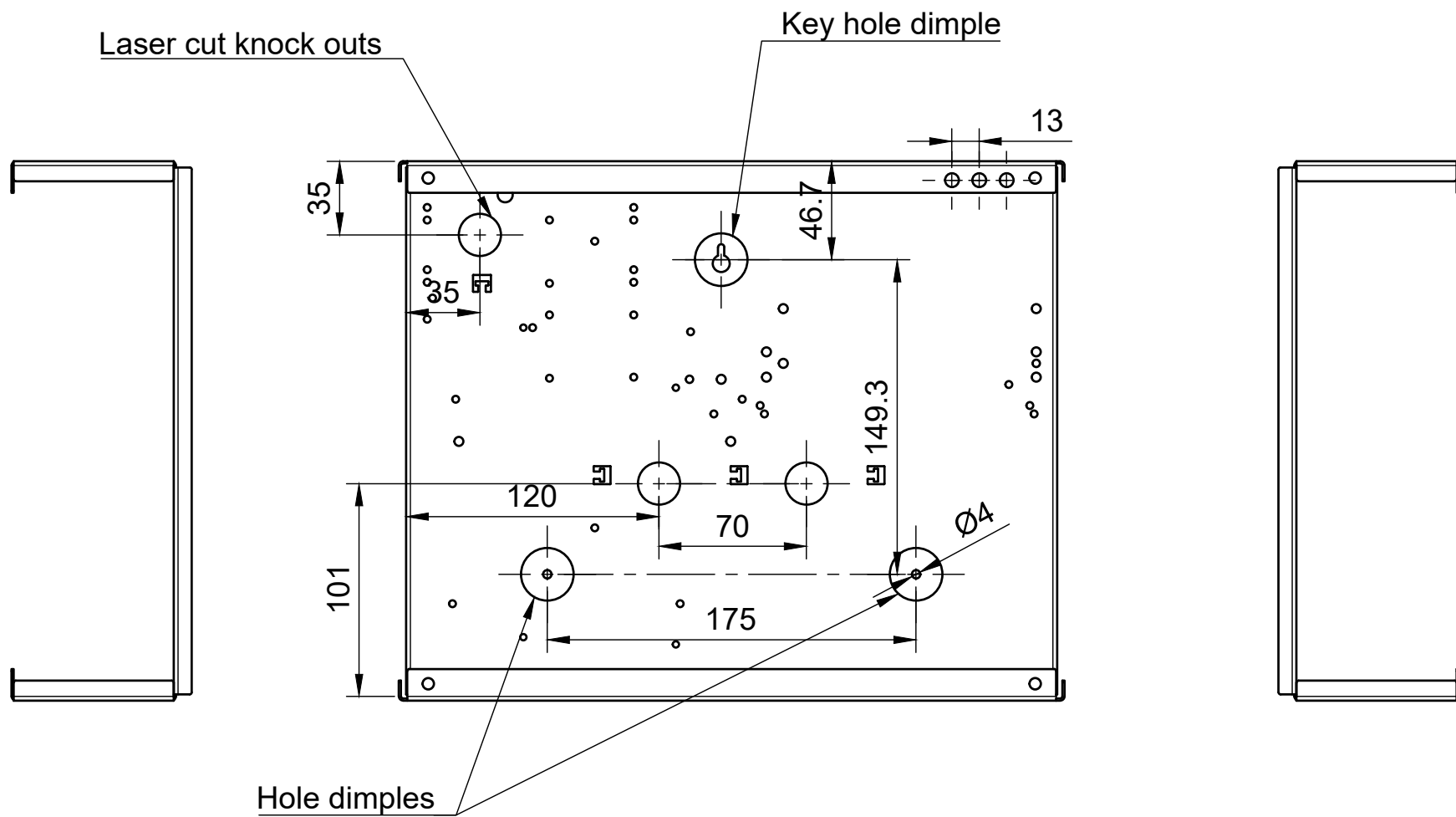

	Description: B Box	Material: Steel
Scale 1:3mm	General Tolerances: +-0.5mm	Projection: 
Date: 09/04/2021 Version:7		

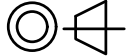
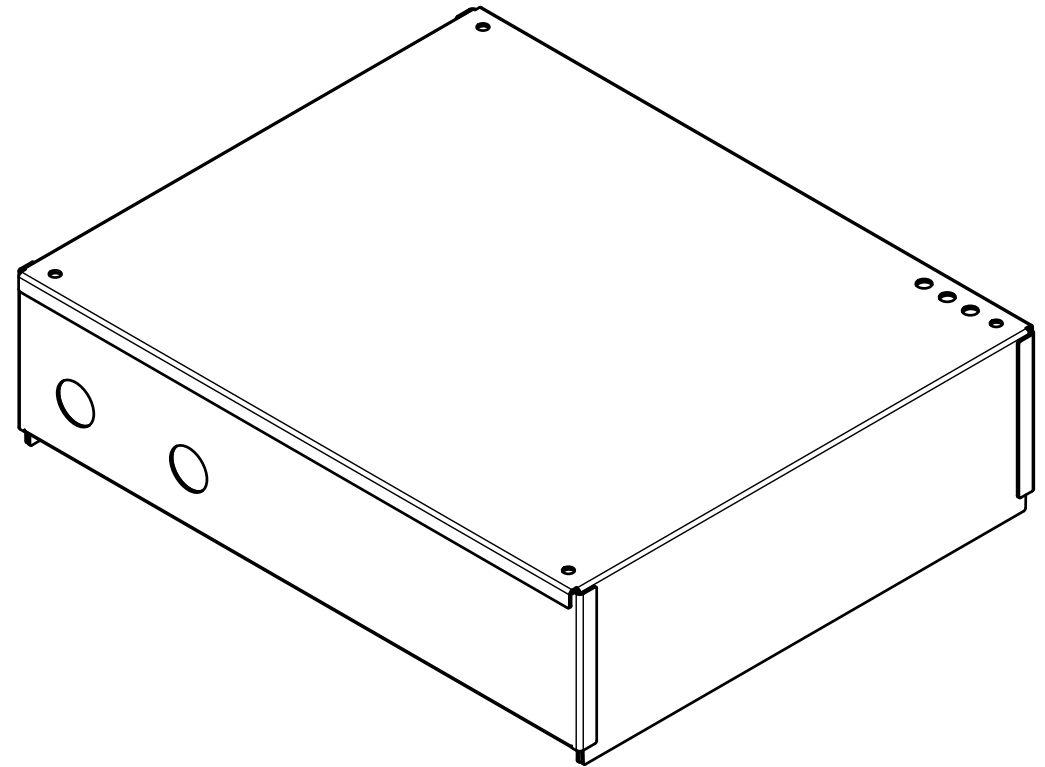
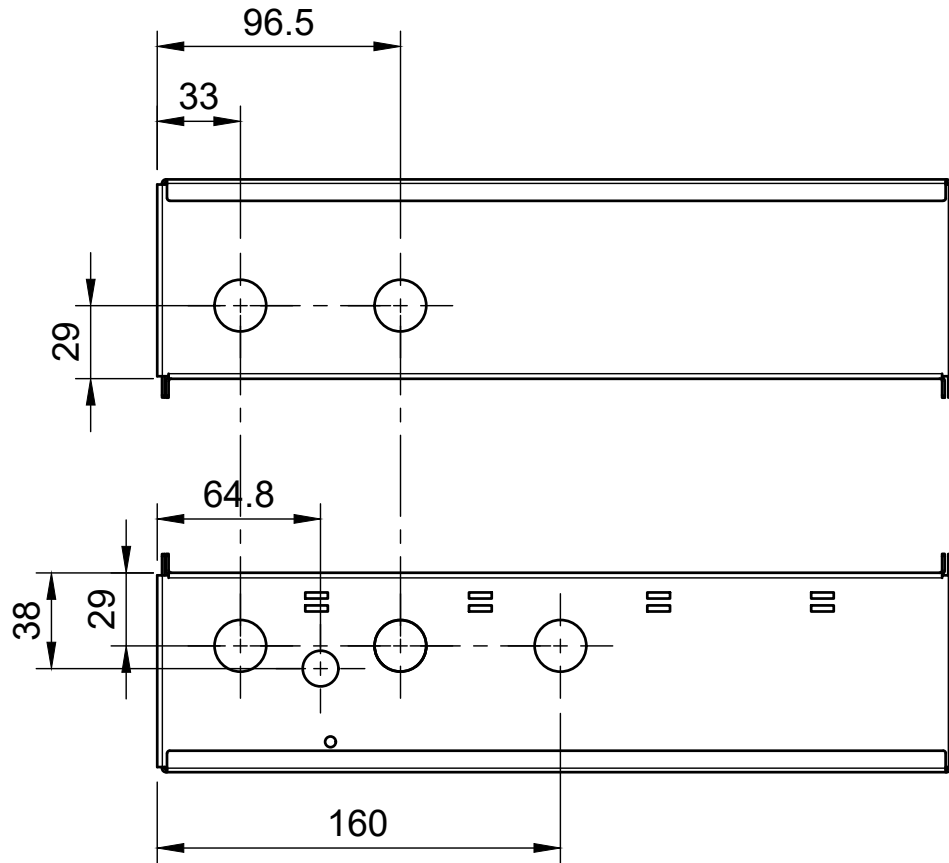
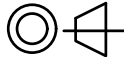

	Description: B Box	Material: Steel
Scale 1:3mm	General Tolerances: +-0.5mm	Projection: 
Date: 09/04/2021 Version:7		