

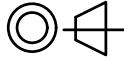

 DYCON power solutions	Description: C Box	Material: Steel
Scale 1:3mm	General Tolerances: +-0.5mm	Projection: 
		Date: 09/04/2021 Version:3

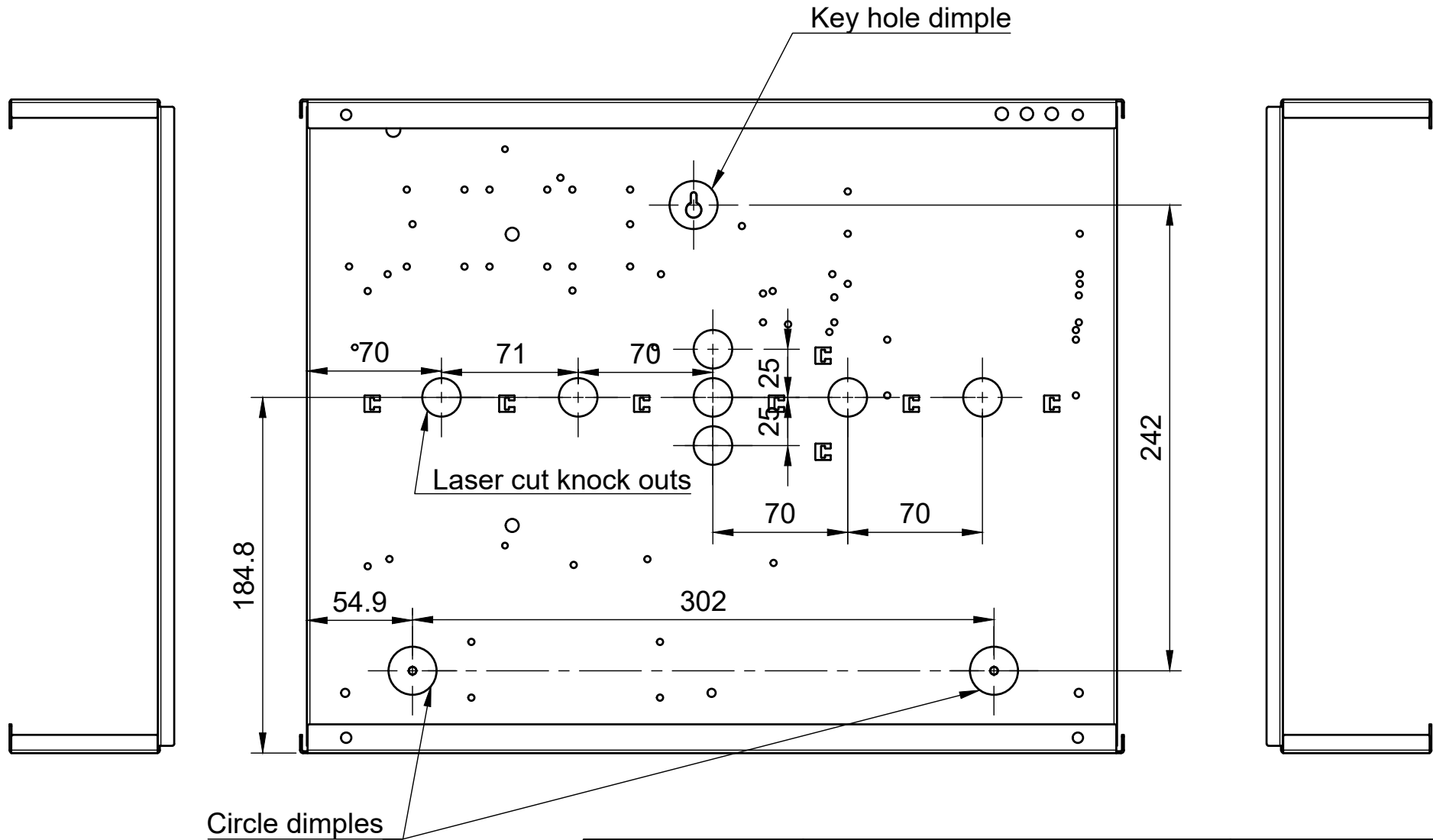

 DYCON power solutions	Description: C Box		Material: Steel
Scale 1:3mm	General Tolerances: +/-0.5mm	Projection: 	Date: 09/04/2021 Version:3

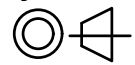
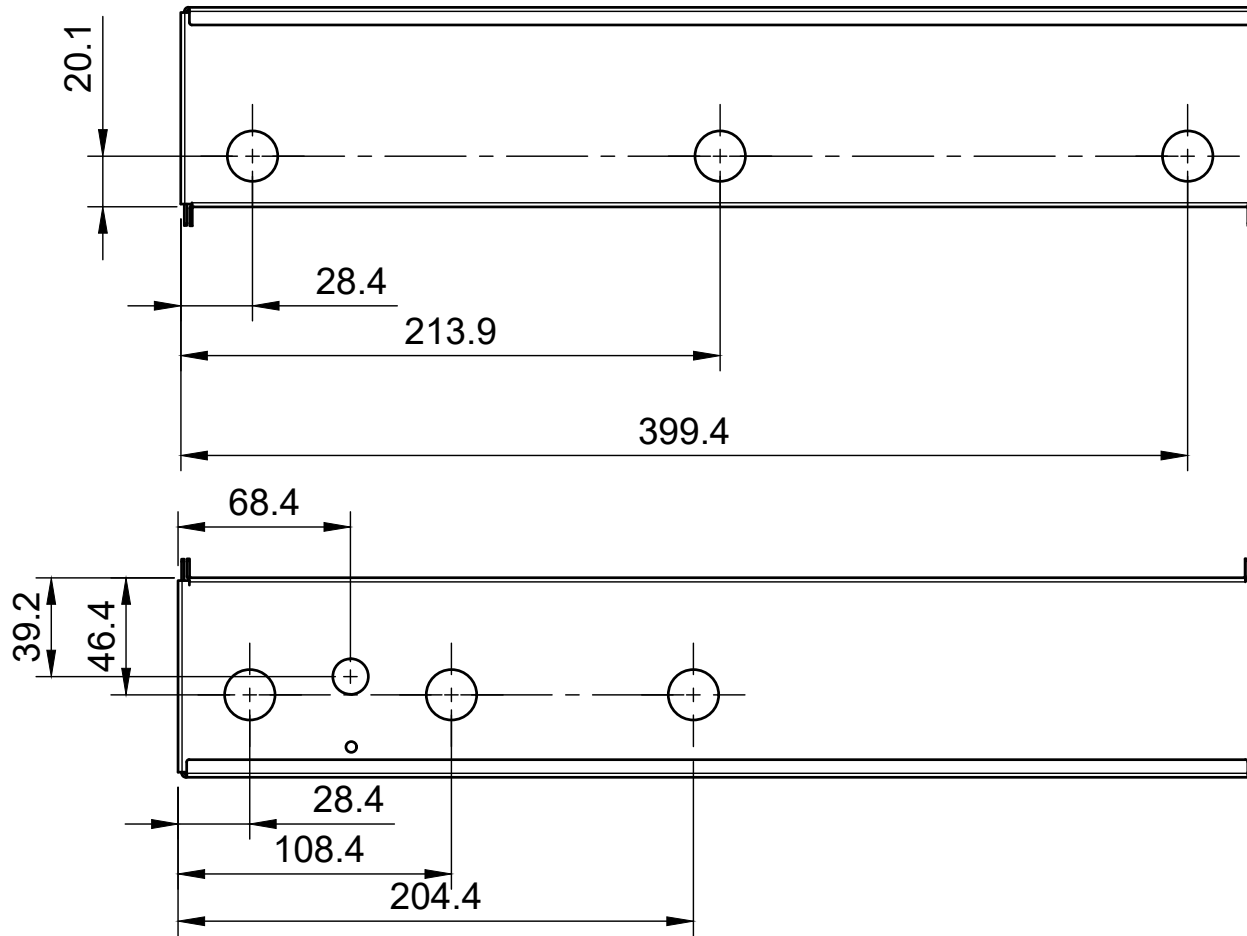

 DYCON power solutions	Description: C Box	Material: Steel
Scale 1:3mm	General Tolerances: +-0.5mm	Projection: 
Date: 09/04/2021 Version:3		

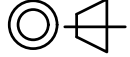
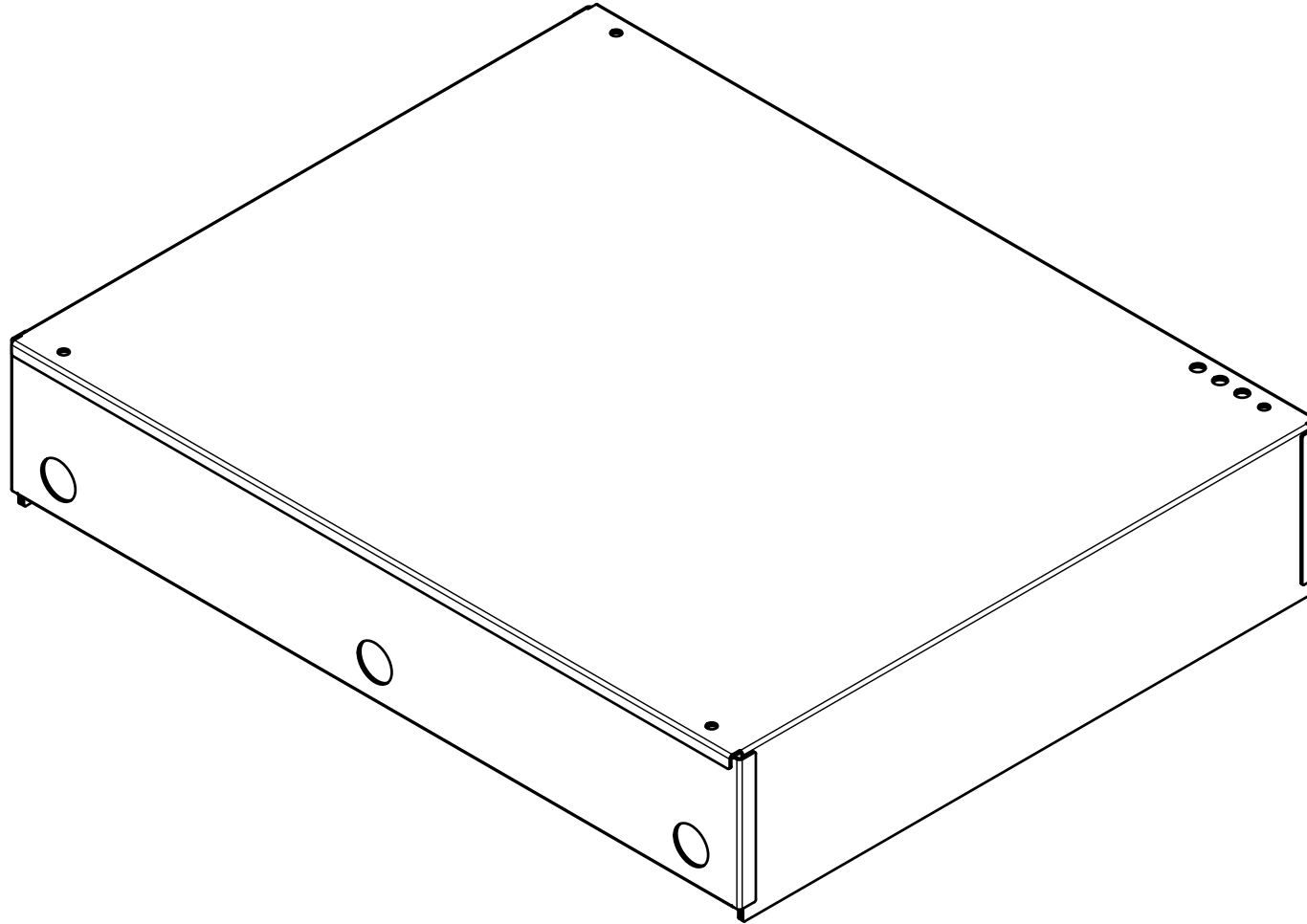

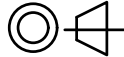
 DYCON power solutions	Description: C Box	Material: Steel	
Scale 1:3mm	General Tolerances: +-0.5mm	Projection: 	Date: 09/04/2021 Version:3