

	Description: G Box	Material: Steel
Scale 1:5mm	General Tolerances: +/-0.5mm	Projection: 
Date: 13/04/2021 Version: 6		

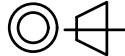

	Description: G Box		Material: Steel
Scale 1:5mm	General Tolerances: +/-0.5mm	Projection: 	Date: 13/04/2021 Version: 6

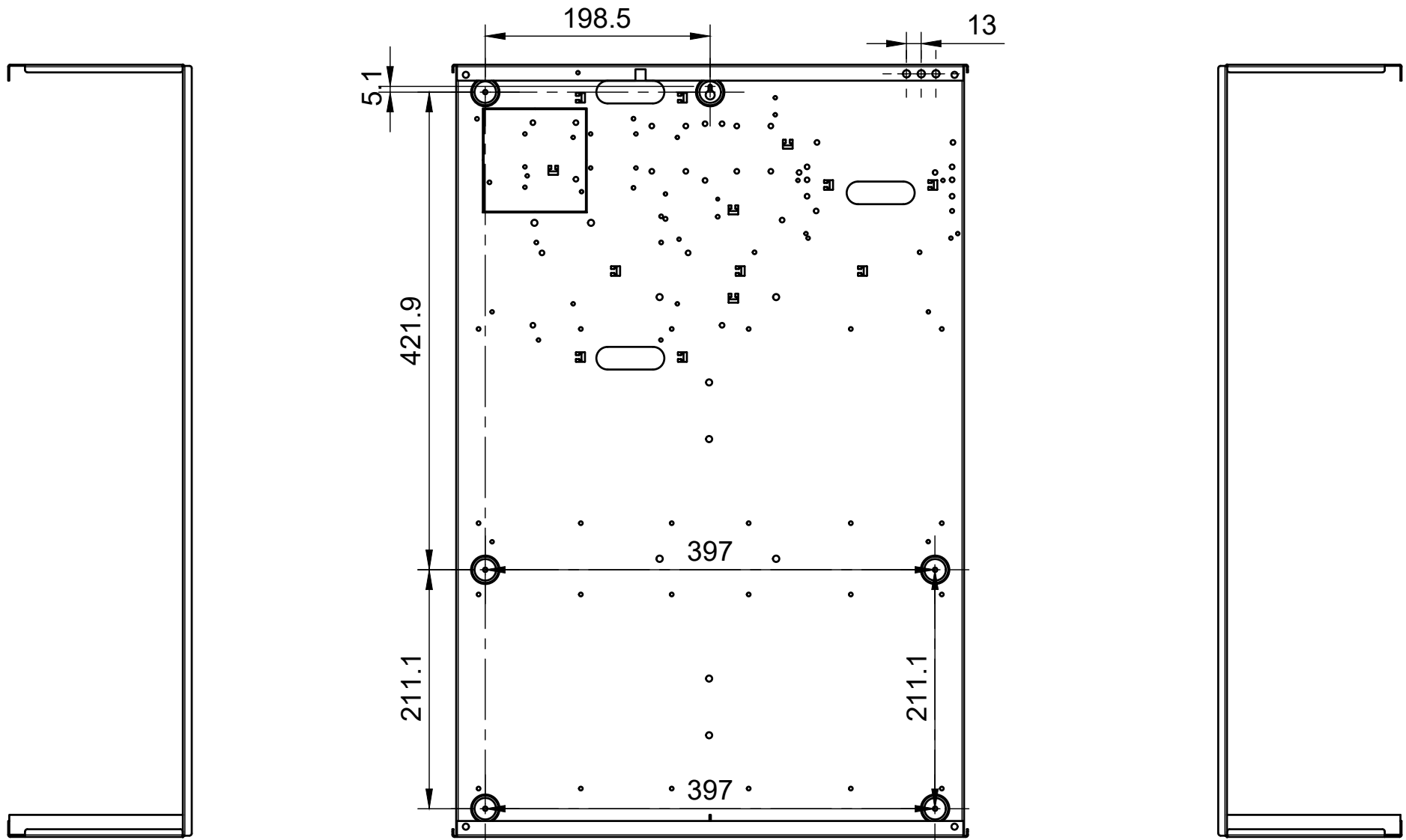

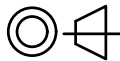
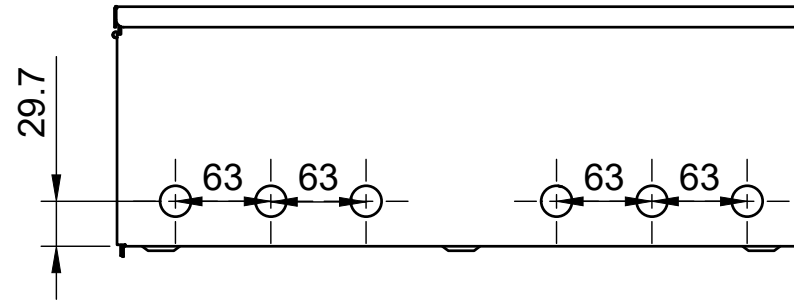
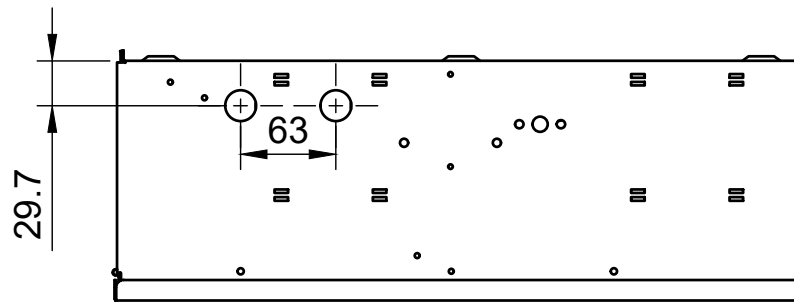

Bottom side

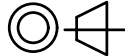

Top side

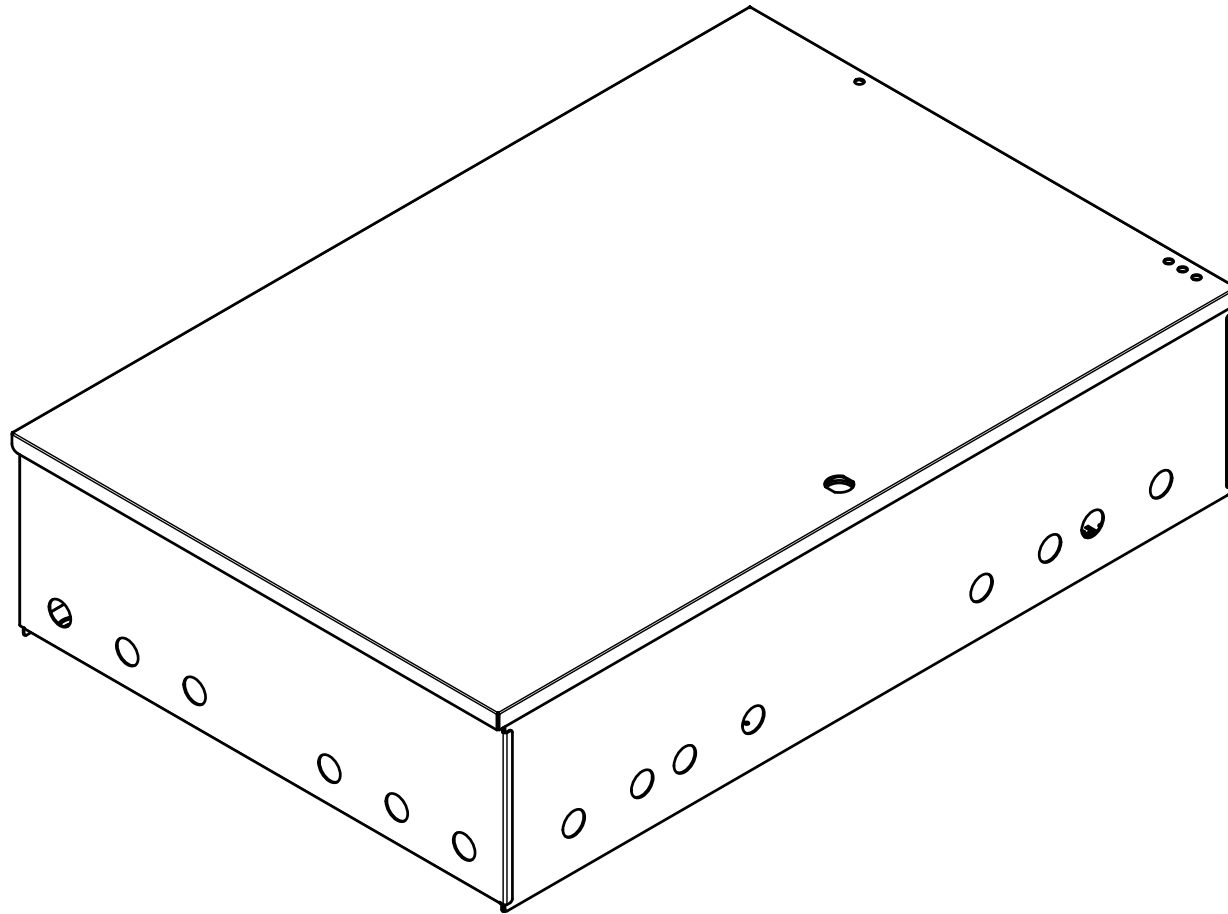
	Description: G Box	Material: Steel	
Scale 1:5mm	General Tolerances: +-0.5mm	Projection: 	Date: 13/04/2021 Version: 6

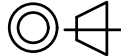

	Description: G Box	Material: Steel
Scale 1:5mm	General Tolerances: +-0.5mm	Projection: 
		Date: 13/04/2021 Version: 6