

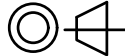

 <b>DYCON</b> power solutions	Description: XLBD Box	Material: Steel
Scale 1:3mm	General Tolerances: +-0.5mm	Projection: 
Date: 13/04/2021 Version:3		

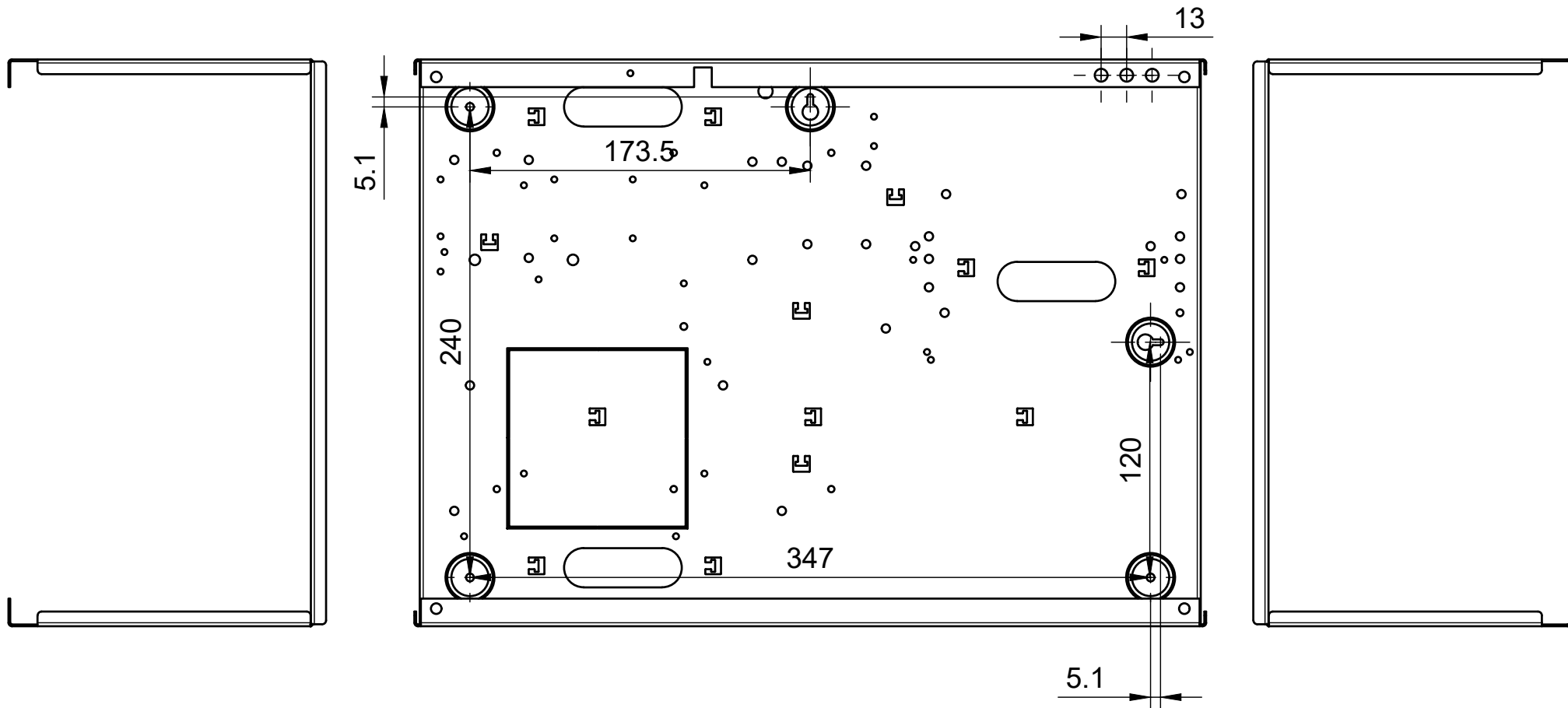

 <b>DYCON</b> power solutions	Description: XLBD Box	Material: Steel
Scale 1:3mm	General Tolerances: +-0.5mm	Projection: 
Date: 13/04/2021 Version:3		

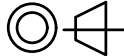
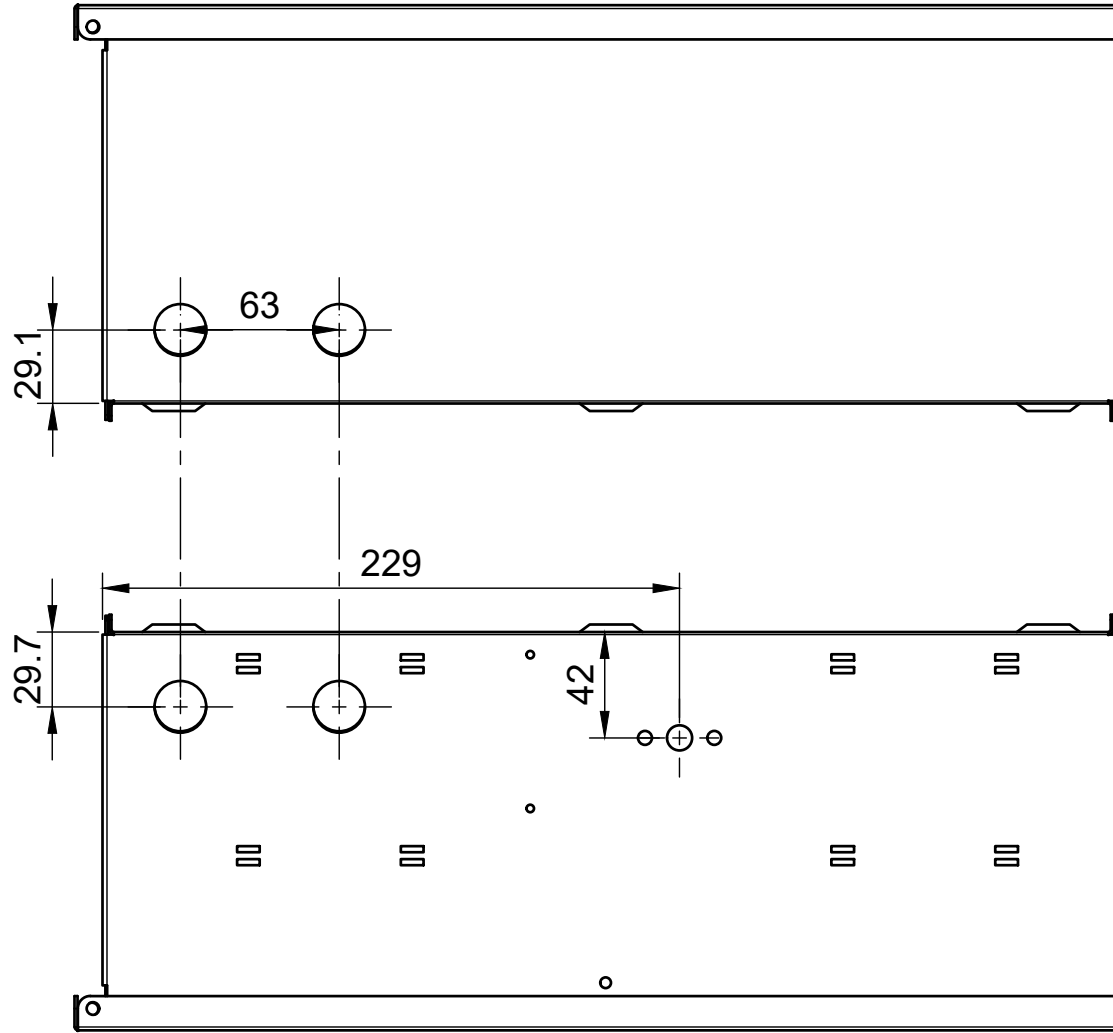

 <b>DYCON</b> power solutions	Description: XLBD Box	Material: Steel
Scale 1:3mm	General Tolerances: +-0.5mm	Projection: 
		Date: 13/04/2021 Version:3

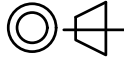
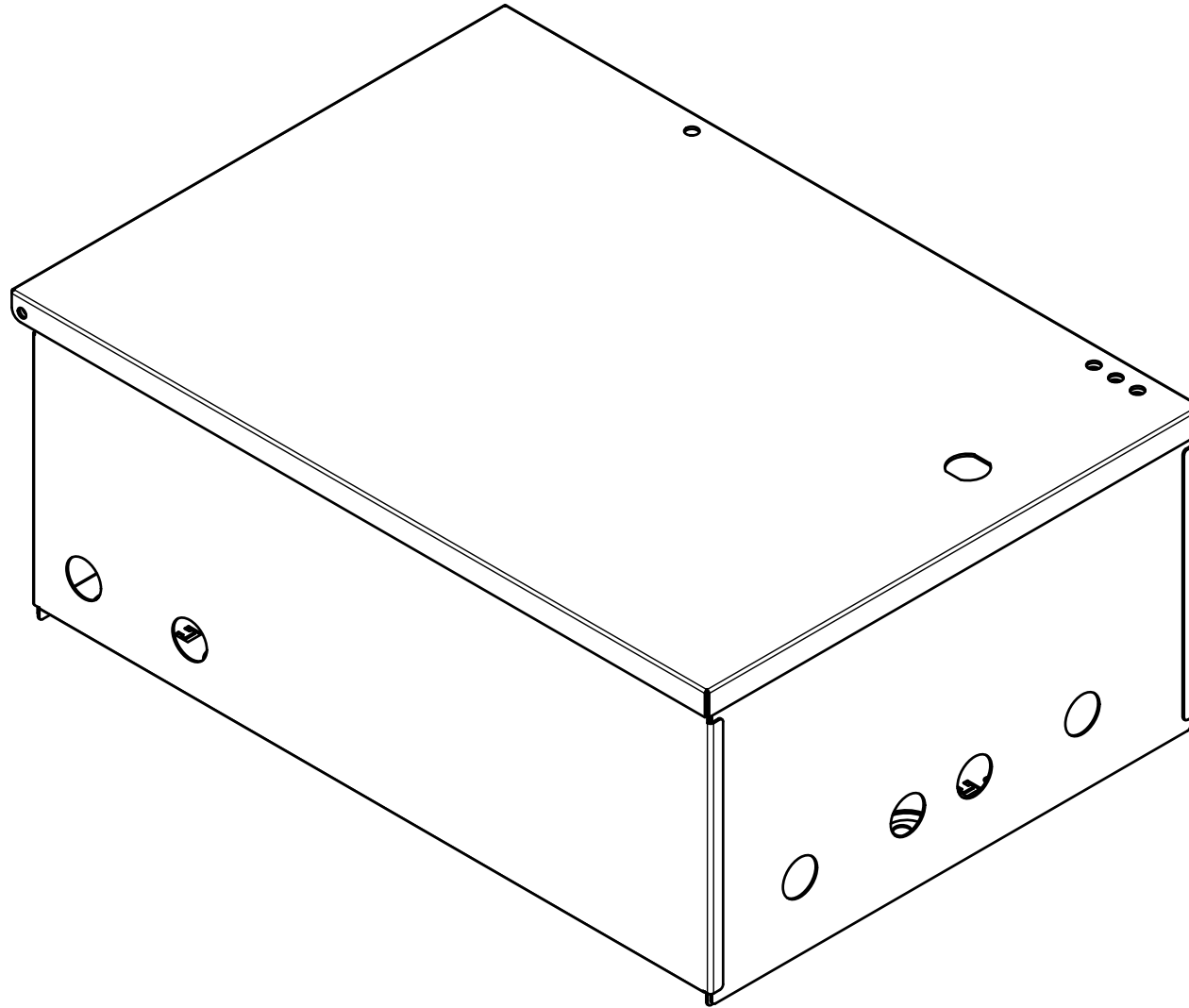

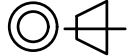
 <b>DYCON</b> power solutions	Description: XLBD Box		Material: Steel
Scale 1:3mm	General Tolerances: +-0.5mm	Projection: 	Date: 13/04/2021 Version:3