

DYCON DATA



A Product Update for Dycon Dealers & Customers

Dycon Housings Capability Edition- Celebrating 20 Years of Innovation!

Founded in 2004, Dycon has focused on installer and user-friendly power solutions, our team understands how security & fire systems work and what they need to operate reliably & efficiently and, they design solutions that meet those needs. Our housings are not just 'tin boxes', they are crucial parts of that total power solution. Dycon's housings offer includes: -

- 11 x steel housings and 19" racks, with 2 x colour options, specially designed for the global security and fire markets, and all made in a local UK factory.
- 1 x IP65 ABS Outdoor, climate & temperature resistant unit.
- All can be supplied ready-fitted with PSU's, splitters, relays & DIN-rails or we can provide the fixings for your own 3rd Party peripherals.
- PSU options 5VDC, 12VDC & 24VDC (with or without battery charging), 48VDC & 24VAC.
- Power outputs 1A, 2A, 3A, 5A, 8A & 10A



Dycon Power Solutions works extensively with professional security/fire system installers and integrators to ensure that they have the right tools to deliver practical, workable, power solutions that enable their systems to be easily installed and to operate reliably. Unlike many other suppliers who provide just a few plain metal boxes, Dycon has always believed that the housing is an integral part of making an installation quicker and less prone to failure and has developed a wide range of different options to help an installer choose the right combination. Part of this thinking is ensuring, right at the start, that the power supply chosen has the right dimensions for the job, that it can fit the available wall space, that it will allow easy cable terminations, and have sufficient space to fit any requisite batteries. Coupled to this is the question of reliable front and, or back, anti-tamper provision, the method of securing the cover/lid and, increasingly, the colour of the box. The Dycon comprehensive Housing Range offers solutions to all these issues and complements the extensive range of Dycon power modules.

Local manufacturing to reduce supply time

Our PCB's and metal housings are locally made in the UK so we have no long-distance supply chains to delay deliveries to you, no waiting for a critical part to be delivered and holding up completion of a full assembly! This local customising facility also enables us to offer a design service when you need something different or modified. We are local, not 10 hours away, you can come and sit with us face-to-face and sort it quickly rather than relying on conference calls!

Let Dycon take the strain.....

To save you time in lining up all various components needed to complete your power installation, making sure they are all in-stock and delivered to you at the same time. Since 2004, Dycon has offered installers and distributors customised PSU's with their specified power supply ready-fitted, along with a choice of a whole range of ancillary devices and facilities such as output splitters, output relay modules, redundancy modules, internal cable trunking and DIN-rails. We will also discuss with you about installing your 3rd Party devices such as access door controllers, our larger housings are already to accept over 10 different makes of such access devices. This is not something new for us, it's an important part of our DNA!

Dycon housing innovations

- From Day 1, we produced housings ready-drilled to accept PSU peripherals such as output splitters, relays, and 3rd party comms and we expanded that from 2010 by supplying complete solutions by include fitting customer-supplied 3rd Party devices.
- To help installers speed up and simplify installations, we designed the innovative XLB range which features totally demountable sides to make cabling quicker, and lockable lid. It also has a clever, quick-installation feature that reduces the need to fit a mains spur, simply use the knock and fit the whole box over the socket.
- The larger XLBD version, has a class-leading depth of 165mm for times when you need to fit larger batteries.



Stage 1 - side & lid removed for basic installation & shows the optional Quick fit' mains option in operation.



Stage 2 - a 4-way output splitter has been added using the pre-drilled holes



Stage 3 - a 17Ah battery & the lid have been fitted



Stage 4 - door locked, installation complete!



- The W-box is an IP65 power solution with over 25 different power and voltage options and featuring another Dycon innovation, a special vent to allow any battery charging gases to safely disperse into the atmosphere without degrading the IP65 rating. This is something that others forget but can be a safety issue and cause a non-compliance failure during Health & Safety inspections.



- Dycon's smallest steel housing, the AA-box, is a very compact, attractive, but tough, steel housing which can be mounted either horizontally or vertically to suit any location. It has rounded corners to lessen the possibility of dirt building up over time. Initially available as a stand-alone box or as the D2410-AA, a 24VDC PSU which is perfect for driving fire doors, this also has an externally visible status LED and a hinged lid, to make installation and servicing quicker.

- In contrast, Dycon's largest standard housing, the G-box, is a full 690mm tall, and has introduced a unique, hinged, module platform that enables extra control modules to be fitted on top of those already installed on the base-plate. These can be accessed and serviced easily when the platform is raised. This enables a G-box to fit more 3rd Part access controllers than most other manufacturers. And, like our other larger housings, the G-box can be supplied predrilled for virtually all the major access control systems controllers. A G-box has space to fit up to 2 x 24Ah or 4 x 17Ah batteries, and Dycon can fit front and back anti-tamper switches to make it EN501312 Grade 2 & 3 compliant.



Standard white G-box, an optional black version is also available.



A G-box with a Dycon D1460 10A PSU and a 17Ah VRLA battery, showing the hinged module platform and the ample space for extra peripherals, cables & more batteries.

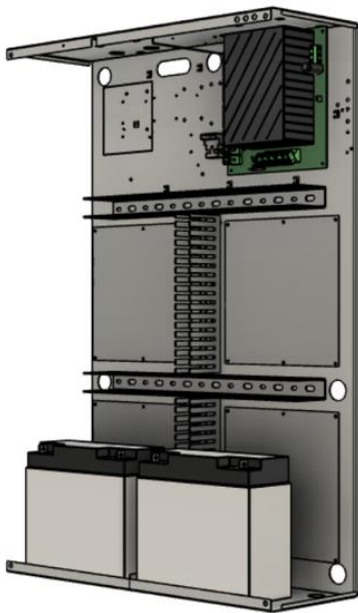

The sides can be removed during installation or servicing, making cabling easier. This view also shows the pre-drilled holes for ancillaries & communication devices.

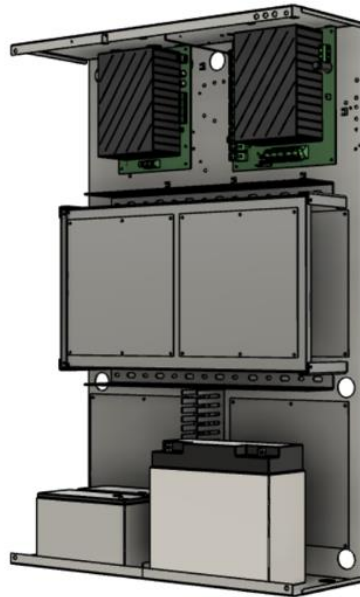

When installation or servicing is complete, the module platform is hinged down and secured. 6 x large (180mm x 180mm) access system controllers can be fitted in the same space as four normally. Dycon CMS01-350 cable management systems are also fitted to ensure that cables are neatly grouped and secured.

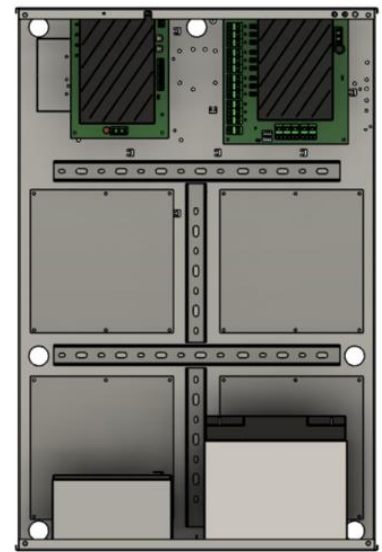

A dual-voltage example showing a 24VDC 5A PSU with 2 x 7Ah batteries on the left, & a 12VDC 9A PSU, with a 17Ah battery on the right.

And Don't Forget.....

We also design and manufacture a full range of matching ancillary matching accessories to complete your installation including, 4- & 8-way output splitters, output relays, dual redundancy modules, cable management systems and magnetic fixing kits for securing PCB's to housings base.

Dycon Standard Housings – specifications

Housing Part No.	Colour	Material	Height	Width	Depth	Weight (without power modules or batteries)	Maximum space available for batteries (see Note *2)
Standard Steel Housings							
AA	White RAL9003	Steel	178mm	110mm	68mm	1.09kg	No battery space
A	White RAL9003	Steel	235mm	170mm	85mm	1.10kg	1 x 7/8Ah
B	White RAL9003	Steel	260mm	320mm	90mm	1.90kg	2 x 7/8Ah or 1 x 17Ah
B-BK	Black RAL9005	Steel	260mm	320mm	90mm	1.90kg	2 x 7/8Ah or 1 x 17Ah
C	White RAL9003	Steel	345mm	430mm	90mm	3.30kg	2 x 7/8Ah or 2 x 17/18Ah
C-BK	Black RAL9005	Steel	345mm	430mm	90mm	3.30kg	2 x 7/8Ah or 2 x 17/18Ah
XB (with clamshell lid)	White RAL9003	Steel	295mm	415mm	90mm	2.20kg	2 x 7/8Ah or 2 x 17/18Ah
XB-BK (with clamshell lid)	Black RAL9005	Steel	295mm	415mm	90mm	2.20kg	3 x 7/8Ah or 2 x 17/18Ah
XLB	White RAL9003	Steel	295mm	415mm	90mm	2.20kg	4 x 7/8Ah or 2 x 17/18Ah
XLB-BK	Black RAL9005	Steel	295mm	415mm	90mm	2.20kg	2 x 7/8Ah or 2 x 17/18Ah
XLBD	White RAL9003	Steel	295mm	415mm	165mm	4.40kg	4 x 17Ah *2
XLBD-BK	Black RAL9005	Steel	295mm	415mm	165mm	4.40kg	4 x 17Ah *2
E	White RAL9003	Steel	405mm	500mm	90mm	5.80kg	2 x 17Ah *2
G	White RAL9003	Steel	690mm	455mm	120mm	8.50kg	2 x 26Ah or 4 x 17Ah *2
G-BK	Black RAL9005	Steel	690mm	455mm	120mm	8.50kg	3 x 26Ah or 4 x 17Ah *2
EN-M7 *1	White RAL9003	Steel	294mm	330mm	90mm	2.50kg	2 x 7/8Ah
EN-L17 *1	White RAL9003	Steel	379mm	395mm	90mm	3.50kg	2 x 17Ah
19" Rack and Mountings							
2U Front plate	Black RAL9005	Steel	482mm	88mm		Overall weight 9.5Kg	*2
2U Main body	Black RAL9005	Steel	440mm	82mm	405mm		
ABS Plastic Climate-Resistant Housing							
W-box (IP65)	Light Grey RAL7035	ABS	245mm	195mm	90mm	1.45kg	1 x 7/8Ah

Key:

*1 = EN54-4 compliant

*2 = The actual number of batteries capable of being housed in any box depends on the size of the main PSU module, the number of system expanders, and the number of 3rd party control modules. Please contact Dycon for more information

Dycon Steel Housings - construction & finishes

- 4 x standard **AA**, **A**, **B** & **C** sizes, a clamshell lid **XB** size, 2 x advanced-specification **XLB** & **XLBD** sizes, 2 x larger **E** & **G** sizes and two special versions, **EN54-7** & **EN54-17**, that can be used both for Dycon EN54-certified fire systems or for normal power supply applications.
- If users prefer the extra security of a clamshell lid, the **XB-box** is a handy size & offers a perfect solution.
- All Dycon metal housings use top quality mild steel and are manufactured here in the UK. The steel thickness used depends on the size of the box and its potential applications.
- The normal lid fixings are M4 zinc-plated screws. The XLB, XLBD & G-boxes all have a keyed-alike cam lock.
- Standard finish is white (RAL9003), powder-coated, spray paint, heat-treated to provide a durable, wipe-clean surface.
- Black (RAL9005), scratch-resistant paint is an option on the **XB**, **XLB**, **XLBD**, **B-box**, **C-box**, **E-box** & **G-Box**
- Custom paint colours can be accommodated only if that colour is available in the type of paint used by our manufacturing process and providing a minimum quantity is ordered. *Please contact Dycon for further information and prices.*

Dycon W-box IP65 Housing

- IP65 - Outdoor, climate & temperature resistant
- Suitable for use with many Dycon power modules
- Available with DIN Rail fixings
- Vertical or horizontal mounting options
- Unique multi-way fixings simplify installation
- Impact resistant ABS construction

Dycon Standard Housings - profiles

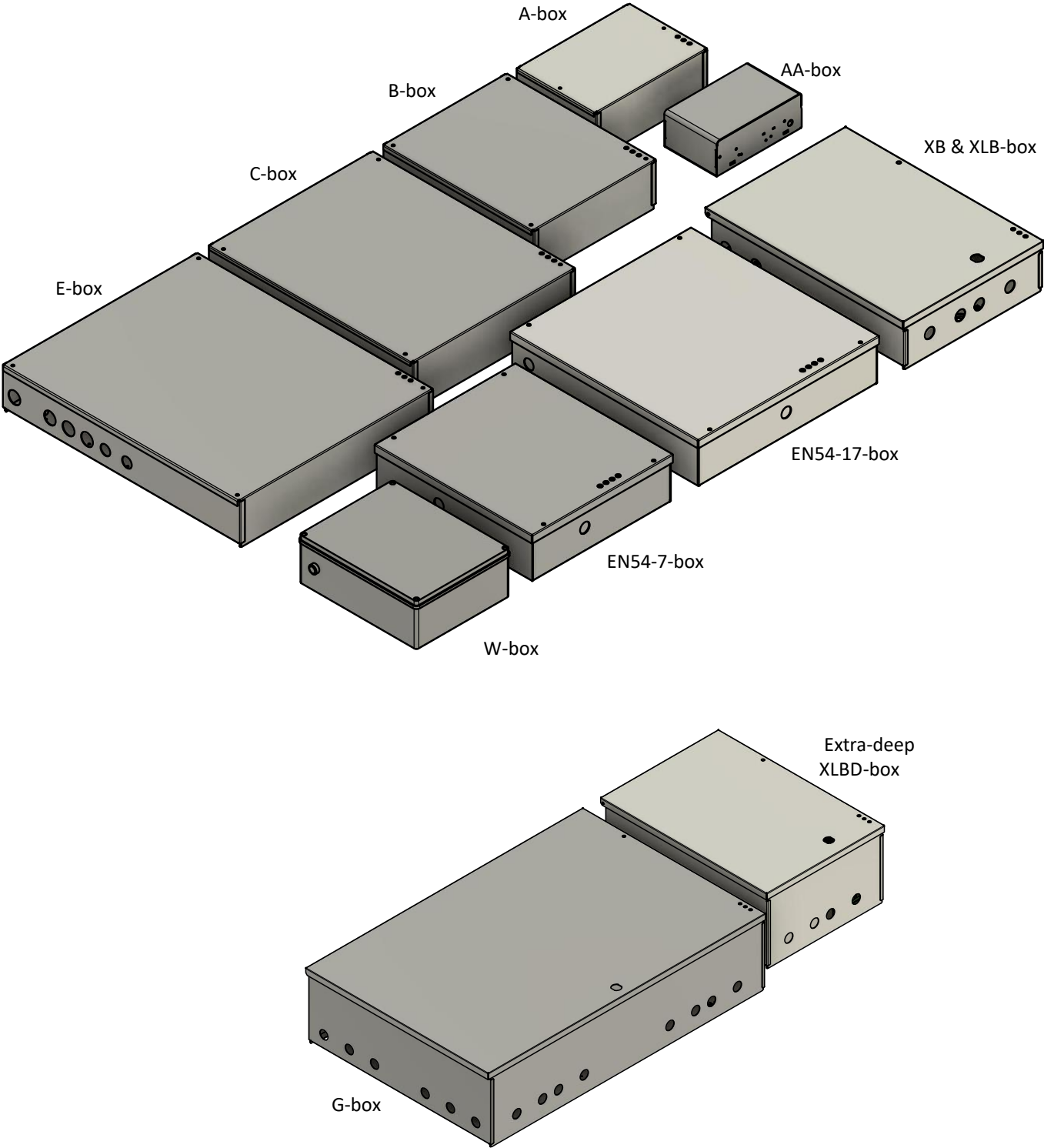

Dycon Standard Housings - dimensions

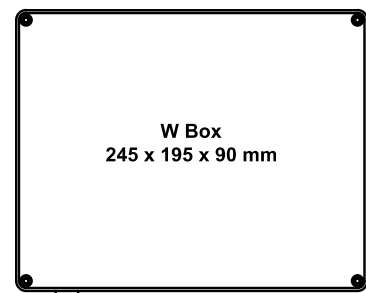
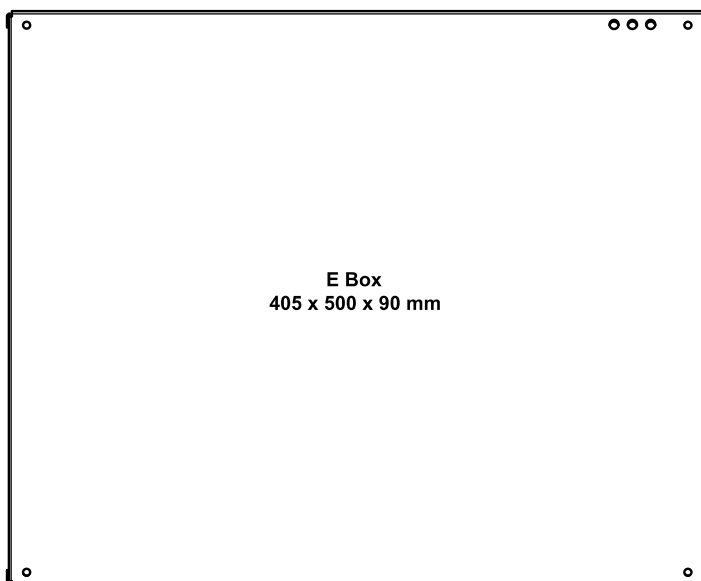
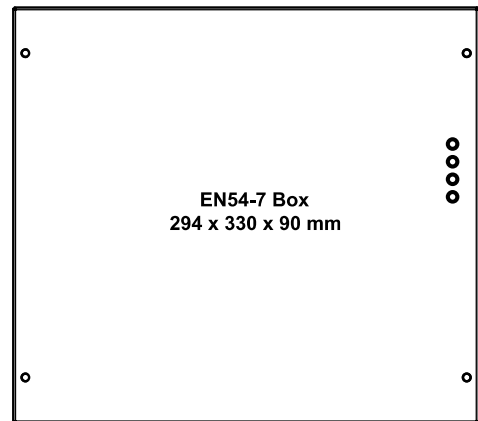
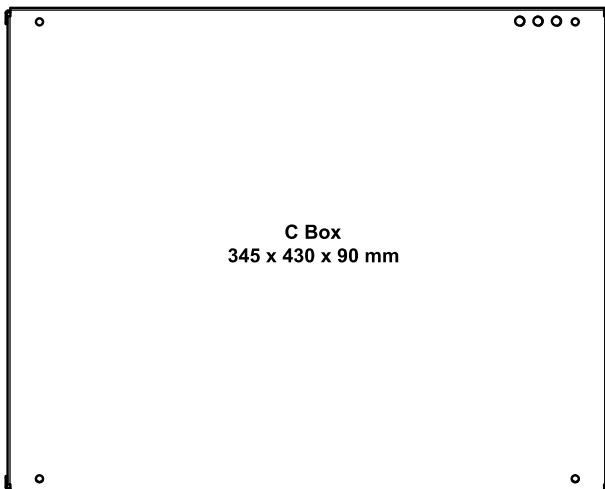
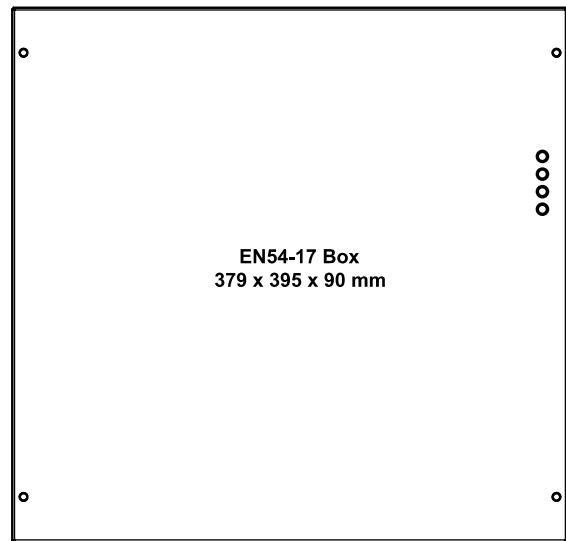
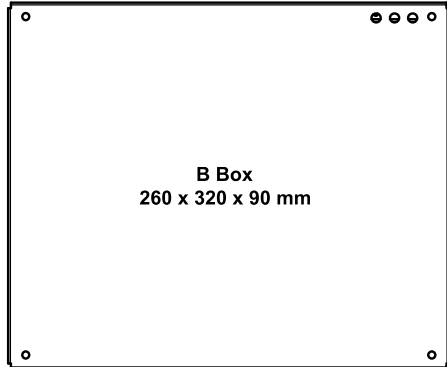
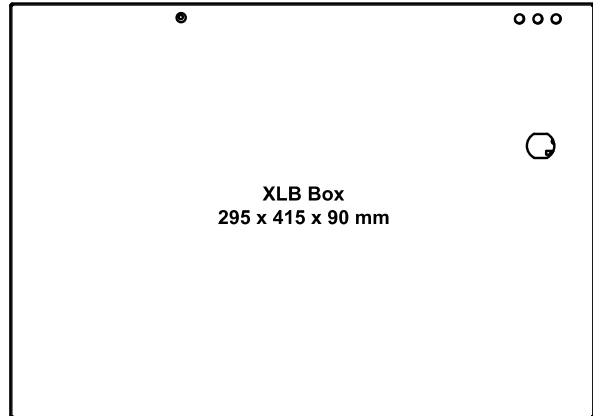
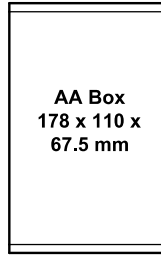
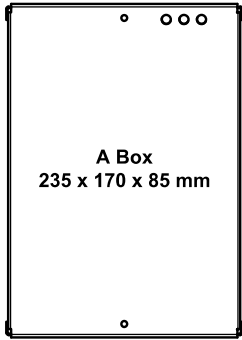

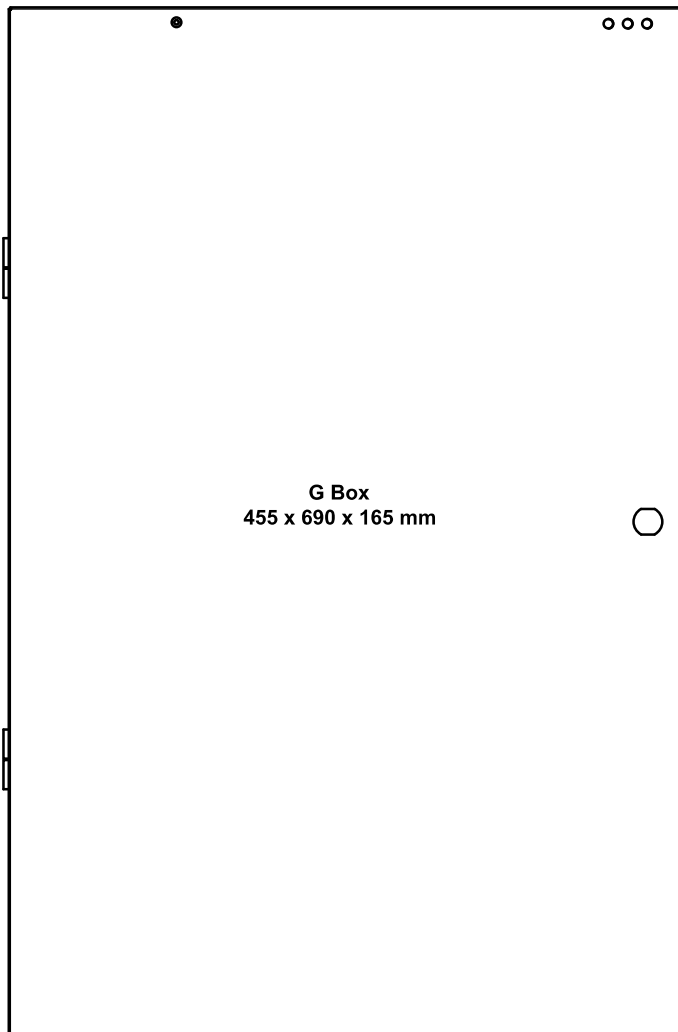
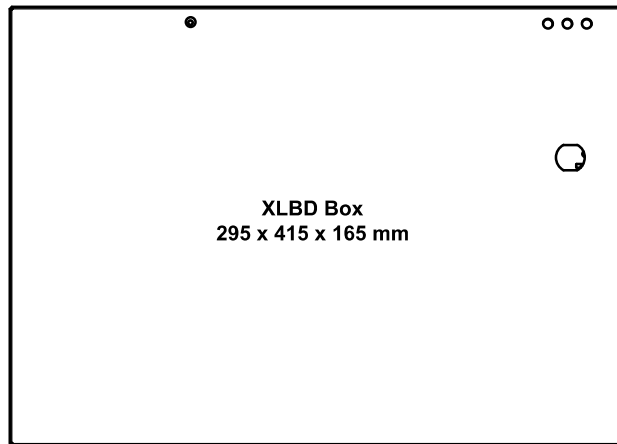

Any questions? Call: +44(0)1443 471 900

For all product data sheets, manuals & drawings go to: www.dyconpower.com

Dycon Power Solutions Ltd

Unit A, Cwm Cynon Business Park, Mountain Ash,
CF45 4ER, United Kingdom.

For more information about the Dycon products:

website: www.dyconpower.com - email: sales@dyconpower.com

Or to discuss your specific needs: +44 (0)1443 471 900

Dycon leads the security and associated power supply markets, with UK design and manufacture of advanced power products, engineered to provide high quality, cost-effective solutions to meet current regulations and the specific needs of system integrators and end-users.

Dycon Data Issue 4 18032024v21